

4G Solar Trail Camera

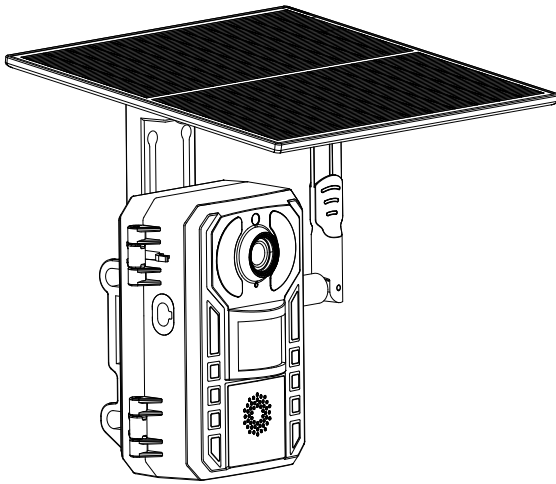

UCon User Guide V1.0

Product Diagram

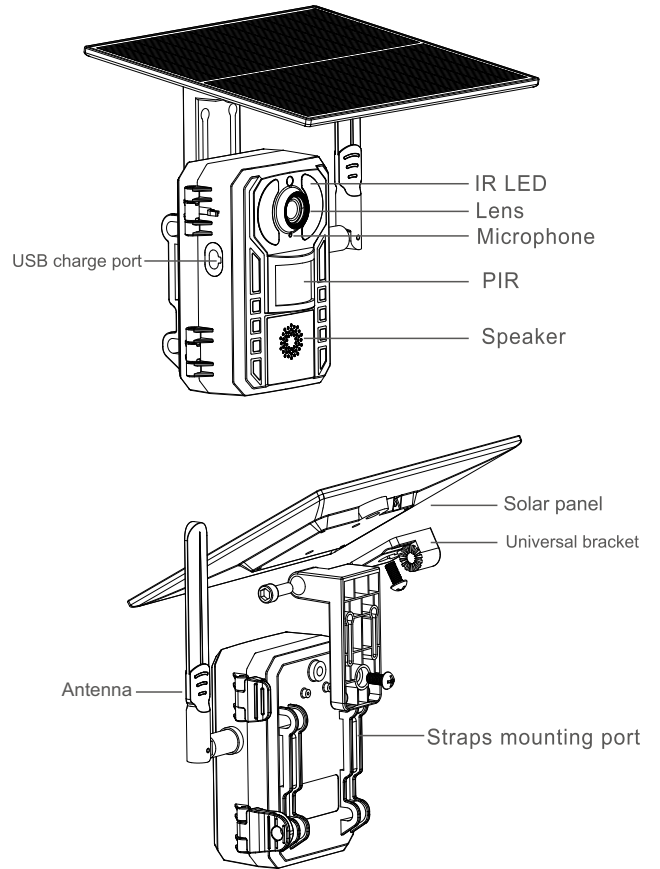

-1-

2.Product Instruction

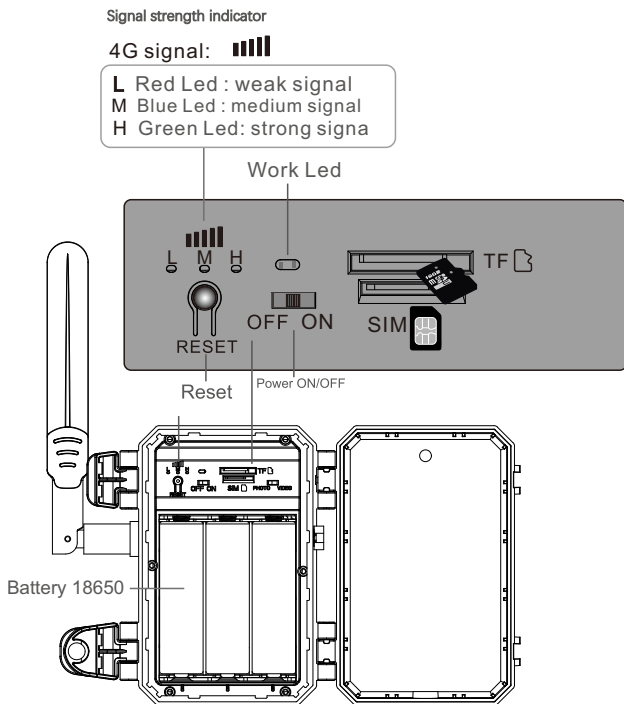

- **Signal strength indicator:** green-strong blue-medium red-weak
- **Reset button:** press and hold for 3S to enter reset pairing state (blue light flashing + prompt tone)
- **Status indicator:** lights up red when powered on, the blue light is always on, you can scan the code to add the device
- **Charging indicator:** the green light is always on during charging, and the light is off when fully charged

-2-

Application Description

1. APP INSTALLATION

(1.) Scan the following QR codes or search for "UCon" from the AppStore(for iOS devices) or Google Play Store (for Android smartphones) to download and install the app.



2. APP REGISTRATION

(1.) Open the app then input your E-mail address then press 'Register'. Check and select to agree the agreement then your E-mail box will get an verification code.
(For better user's experience, please allow to open all permissions to avoid missing any notifications from the app.)

(2.) Set the login password and confirm the login password. Then press 'Register' to next step. (For your password safety, the password requires more than 8 characters plus combination of letters)

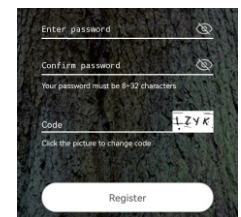
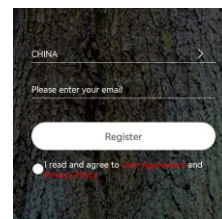

(3.) We send a verify mail to you, go to your mail box click the link to complete the verification.

(4.) Enter your E-mail address, and password, click login. (APP will auto fill the account info)

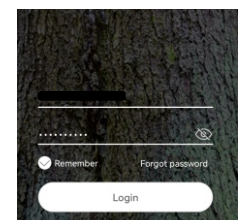
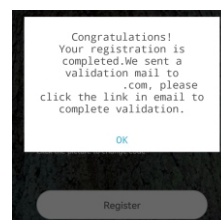

-3-

3. CONNECTION

(1.) Press 'Add Location' then set the room or position as per reminders.

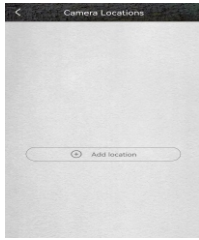

(2.) Enter your family name and then press 'Next'.

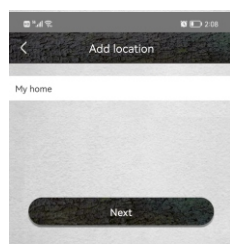

(3.) Input the necessary information just like Country, Province, then press 'Done'.

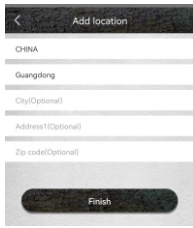

(4.) Press 'Add a device' to add a smart device



(5.) insert the SIM card into device then put the battery into the device , and some of models need install antenna.

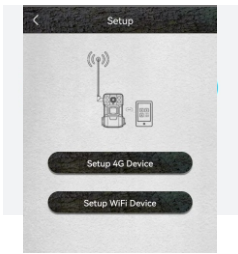

(6.) After the power on the device, wait for about 1 minute the device blue LED light up , Then press next.



-4-

(7.) If the device blue LED not light up, please check below config notes.



(8.) Find the UID QR code on camera , then use APP scan the QR code.



(9.) APP are search the device in internet it may take 5-60 seconds.

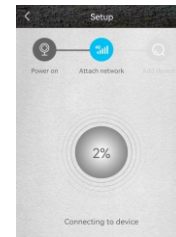

(10.) Select the name and device location then press 'Done'.

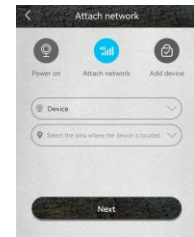

(11.) The device will enter to the device list automatically. Setup success! The device is ready to use.

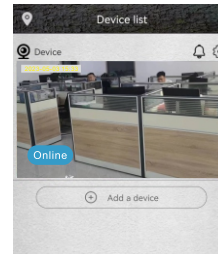

(12.) Notes about PIR detection

*The user can adjust the sensing distance by changing the PIR detection sensitivity..

*Low: The detection distance can reach up to 9 meters.
*Medium: The detection distance can reach up to 14 meters.
*High: The detection distance can reach up to 20 meters.

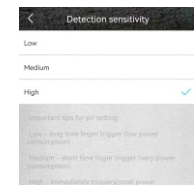

-5-

4. USING THE APP

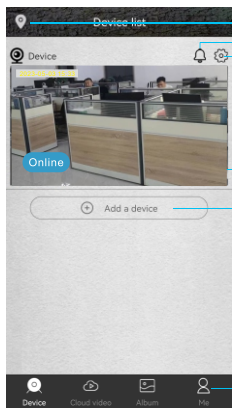

Enter to select your family or smart device location

Turn on/off the push notification.

Settings: Sharing, Cloud storage, Delete the device.. VIDEO PHOTO Mode Switch

Press to enter the preview section.

Press to add a smart device

Account and value-added account management

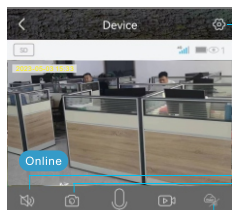

Smart device basic settings
Could set "Storage management, Flip screen, Environmental model,PIR detection, Sleep time, Power frequency, LED indicator, Device name"
Could check the information of "Device name, Device ID, Model, FW version, Manufacturer, Check for the FW updates.."

Turn on/off the speaker

Screenshot

Playback switch 'Micro SD memory' and 'Cloud storage'

Take a video for the live view

Microphone - Speak to the smart device side.

-6-

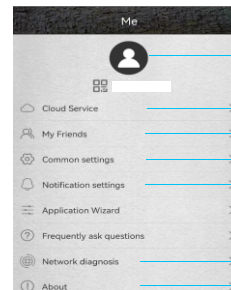

Check "my account" name and change password;

Check and purchase the Cloud storage;

Check and add my friends list and permission;

Set the default voice and resolution for the devices;

Push settings (including auto run management, permission management, battery management and accept call)

Check the network signal strength.

Check the App version.

Click the "Calendar" icon on the right top corner , then choose the date to playback the vicoes from cloud storage.

Select the date you want to view videos or pictures in TF card and cloud storage

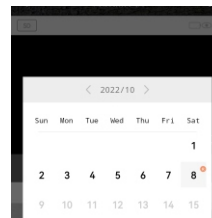

The contents of video mode and picture mode can be seen in playback

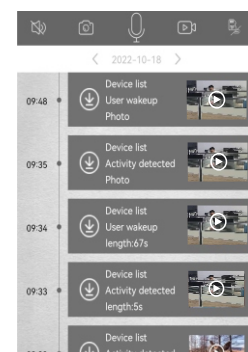
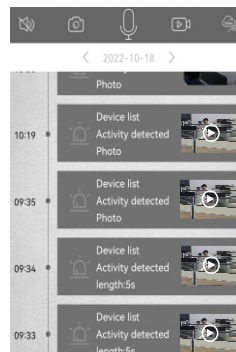

-7-